

Lab Rats Performance



**INSTRUCTIONS:
PLEASE READ BEFORE INSTALLATION!!!**

Lab Rats Performance

1.0 INTRODUCTION

This harness is constructed with GM Delphi Connectors and Terminals with GXL/TXL (600 volt polyethylene cross-linked) wire which is professionally assembled and 100% quality inspected prior to shipping. This harness includes all wiring that is needed by the PCM to run and control the fuel injection system and transmission.

TABLE 1. LIST OF COMMON TERMS

Description	Term	Purpose
Powertrain Control Module	PCM	This is the computer which controls all functions.
Throttle Position Sensor	TPS	PCM Input for engine throttle position.
Idle Air Control	IAC	PCM Output to control Idle RPM.
Exhaust Gas Recirculation	EGR	PCM Output to control engine emissions.
Engine Coolant Temperature	ECT	PCM Input to determine engine temperature.
Inlet Air Temperature	IAT	PCM Input to determine air temperature.
Manifold Absolute Pressure	MAP	PCM Input to determine engine load.
Mass Air Flow	MAF	PCM Input to determine airflow into engine.
Oxygen Sensor	O2	PCM Input to determine air/fuel ratio of engine.
Vehicle Anti-Theft	VATs	PCM Input to prevent engine from starting.
Charcoal Canister Purge	CCP	PCM Output to control engine emissions.
Malfunction Indicator Light	MIL	PCM Output to alert of EFI Malfunction.
Data Link Connector	DLC	PCM Input for retrieving trouble codes.
Torque Converter Clutch	TCC	PCM Output for locking torque converter.
Vehicle Speed Sensor	VSS	PCM Input to determine vehicle speed.

2.0 PRECAUTIONS

BELOW ARE A FEW PRECAUTIONS THAT SHOULD BE TAKEN PRIOR TO AND AFTER INSTALLING THIS WIRING HARNESS:

1. Never disconnect the battery or the PCM Connectors while the ignition is turned 'On'.
2. Never short any wires in this harness to ground (with the exception of the 'Ground' wires) or damage to the PCM will result.
3. Never use a 'Test Light' to determine the condition of any circuits. A digital Volt/Ohm Meter with a minimum of 10-Mohm resistance is required to test any circuits. Do not back probe wires as this can lead to permanent wire damage.

Lab Rats Performance

3.0 PRE-INSTALLATION REQUIREMENTS

THE FOLLOWING INFORMATION DETAILS SOME OF THE HARDWARE AND SOFTWARE REQUIREMENTS WHEN INSTALLING THIS HARNESS:

(SEE TABLE 2 FOR COMPATIBLE REPLACEMENT SENSOR PART NUMBERS)

1. All LS1 Engines will require the VAT's System to be removed from the PCM. If the VAT's is not removed from the PCM the engine will NOT start.
2. Factory Stock Engines utilized four (4) O2 Sensors; two (2) Sensors on each side of the engine, one before and one after the catalytic converter. The rear O2 Sensors (after the catalytic converters) are **not** used with the harness. Provisions are provided for two oxygen sensors in the harness. (SEE TABLE 2 FOR SENSOR PART NUMBERS)
3. All LS1 Engines utilized an EGR, AIR Pump, and CCP features for emissions control. This harness does not include these provisions. EGR, Air Pump, and CCP are not necessary for engine operation. PCM reprogramming may be necessary to avoid storing a Diagnostic Trouble Code (DTC) for absence of emissions equipment.
4. If any sensors are missing or damaged, it should be replaced. Replacements are listed in Table 2. Note that the PCM listed in Table 2 must be used.
5. When using a 4L60E or 4L80E transmission you **MUST** have a two-position brake switch. These are necessary to allow proper function of the TCC. The brake switch should be closed (electrically connected) when the brakes **ARE NOT** being applied and open (not electrically connected) when the brakes **ARE** being applied. This is the opposite of a standard brake light switch.

CAUTION: FAILURE TO WIRE THE TCC SWITCH CORRECTLY WILL RESULT IN A DANGEROUS SITUATION IN THE VEHICLE WHERE THE TORQUE CONVERTER MAY NOT UNLOCK.

4.0 TOOLS

Non-Standard Tools Required for Installation:

1. Terminal Crimping Tool
2. Wire Strippers
3. Electric Drill
4. 2" Hole saw (for the rubber grommet in the firewall)

5.0 ROUGH INSTALLATION/ROUTING

This harness was designed with the intent of PCM mounting in the passenger compartment (e.g. glove box, or under dash). This fuel injection harness has two sections, the Engine Compartment Section, and the Dash Section, reference Figure 1 below. Note that the Engine Compartment Section is on one side of the Grommet Seal and the Dash Section is on the other side.

- **ENGINE COMPARTMENT SECTION:** Includes wiring for the fuel injectors, coils, sensors, and transmission (if applicable).
- **DASH SECTION:** Includes ignition feed wire, DLC Connector, Underdash Wires, PCM Connectors, Chassis Ground, and Fuse/Relay Center.

Lab Rats Performance

5.1 Decide where and how the PCM and Fuse/Relay Center will be mounted. Lab Rats Performance wiring harnesses are designed to mount either under the dash or in the kick panel on the right side. They must be no further apart than the wiring will allow.

5.2 A good exercise is to lay out the wire harness on the floor beside your vehicle and identify all the connectors and wires.

5.3 You will want to route the harness through and around open areas. Inside edges provide extra protection from hazards and also provide places for tie wraps, clips and other support.

5.4 Route the harness away from sharp edges, exhaust pipes, and the hood, trunk and door hinges.

5.5 Allow enough slack in the harness at places where movement could possibly occur (body to frame, frame to engine, etc.).

5.6 Familiarize yourself with the harness by locating each of the harness sections and by looking at the connectors on the wire ends, reference Figure 1.

NOTE: As with all automotive wiring, the grounding circuit is critical for proper operation. Ensure that there is secure grounding of the following, battery to engine, battery to chassis, engine to chassis, harness to engine, and harness to chassis.

This harness is equipped with Ground Wiring on the rear portion of the driver side cylinder head and adjacent the fuse block supplied with the harness.

5.7 Connect a ground strap or cable (minimum of a 4 Ga. wire) from the negative battery terminal to the chassis (frame).

5.8 Connect a ground strap (minimum of a 4 Ga. wire) from the engine to the chassis (frame). **DO NOT RELY UPON THE MOTOR MOUNTS TO MAKE THIS CONNECTION.**

5.9 Connect a ground strap from the engine to the body.

6.0 HARNESS INSTALLATION

CAUTION: BEFORE BEGINNING INSTALLATION, DISCONNECT THE POWER FROM YOUR VEHICLE BY REMOVING THE NEGATIVE BATTERY CABLE FROM THE BATTERY.

Connecting the Wiring Harness is a simple process and is detailed in the following steps.

6.1 Mark the position where the wiring harness will come through the firewall with a metal punch. Using a 2" hole saw, drill a hole in the firewall. Make sure to debur the hole with a file.

6.2 From **inside** the vehicle, feed the Engine Section of the wiring harness through the 2" hole. Push the grommet (already installed on the harness) into the hole until it is seated.

NOTE: Make no wire connections or permanent mounting of any kind at this time. Remember to route harness away from sharp edges, exhaust pipes, hinges and moving parts.

6.3 Route the engine compartment section to the top of the engine. The engine section is designed to be separated into left side (driver) and right side (passenger) sections, in much the same

Lab Rats Performance

way as factory wiring. Each side is wire loomed separately, BUT IS NOT LABELED. The driver side of the engine section has the connectors for the IAC, TPS, IAT, and MAF Sensor, reference Figure 1.

- 6.4 Route the driver side section between the driver side rocker cover and fuel rail.
- 6.5 Route the passenger side section between the passenger side rocker cover and fuel rail.
- 6.6 If applicable, route the transmission connector and VSS connector over the transmission case to the rear of the transmission.

CAUTION: WHEN ROUTING THE WIRES FOR THE VEHICLE SPEED SENSOR MAKE CERTAIN THAT THEY ARE AT LEAST 12 INCHES AWAY FROM ANY IGNITION WIRING (SPARK PLUG WIRES, ETC.).

- 6.7 Route the Battery Positive (**2 LARGE RING TERMINALS COVERED IN RED HEAT SHRINK**) and Crank sensor connectors behind the passenger head and under the exhaust manifold (header) to their respective locations.

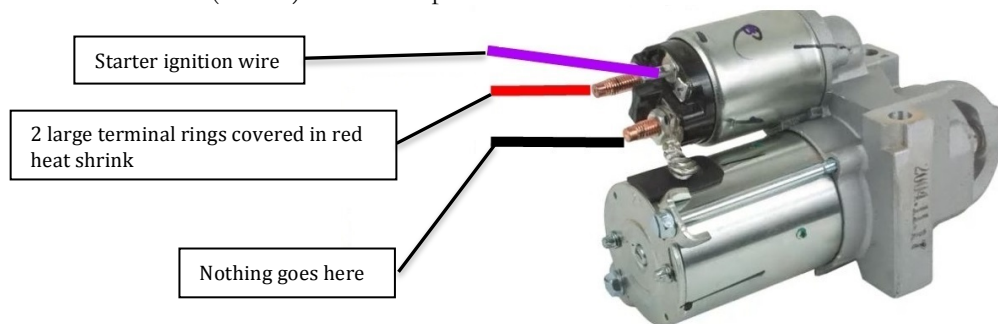

- 6.8 Route the Fuse Block/Relay Center and PCM connectors to their preferred mounting locations. Position the PCM in its intended location (e.g. under the dash).

CAUTION: IT IS IMPORTANT TO AVOID PCM CONTACT WITH MOISTURE OR DAMAGE MAY OCCUR.

- 6.9 Route the underdash wires, Figure 1, to the driver side of the dash.

7.0 ENGINE COMPARTMENT SECTION CONNECTIONS

- 7.1 Locate the black wires in the driver side group that end in two, small ring terminals and ground them to the engine, Figure 1. (Commonly to the rear of the driver side cylinder head).
- 7.2 Using Figure 1 and specific connections indicated in Table 3 connect the wiring as directed.
- 7.3 Route the transmission connector to the passenger side of the transmission and attach it.
- 7.4 Route the connector for the Vehicle Speed Sensor (VSS) and connect it to the Vehicle Speed Sensor on the tailshaft of the transmission.

NOTE: If using a 4L80E transmission, a separate Input Speed Sensor (ISS) connection will be present in the harness. This is plugged into the sensor towards the front of the transmission bell housing.

Lab Rats Performance

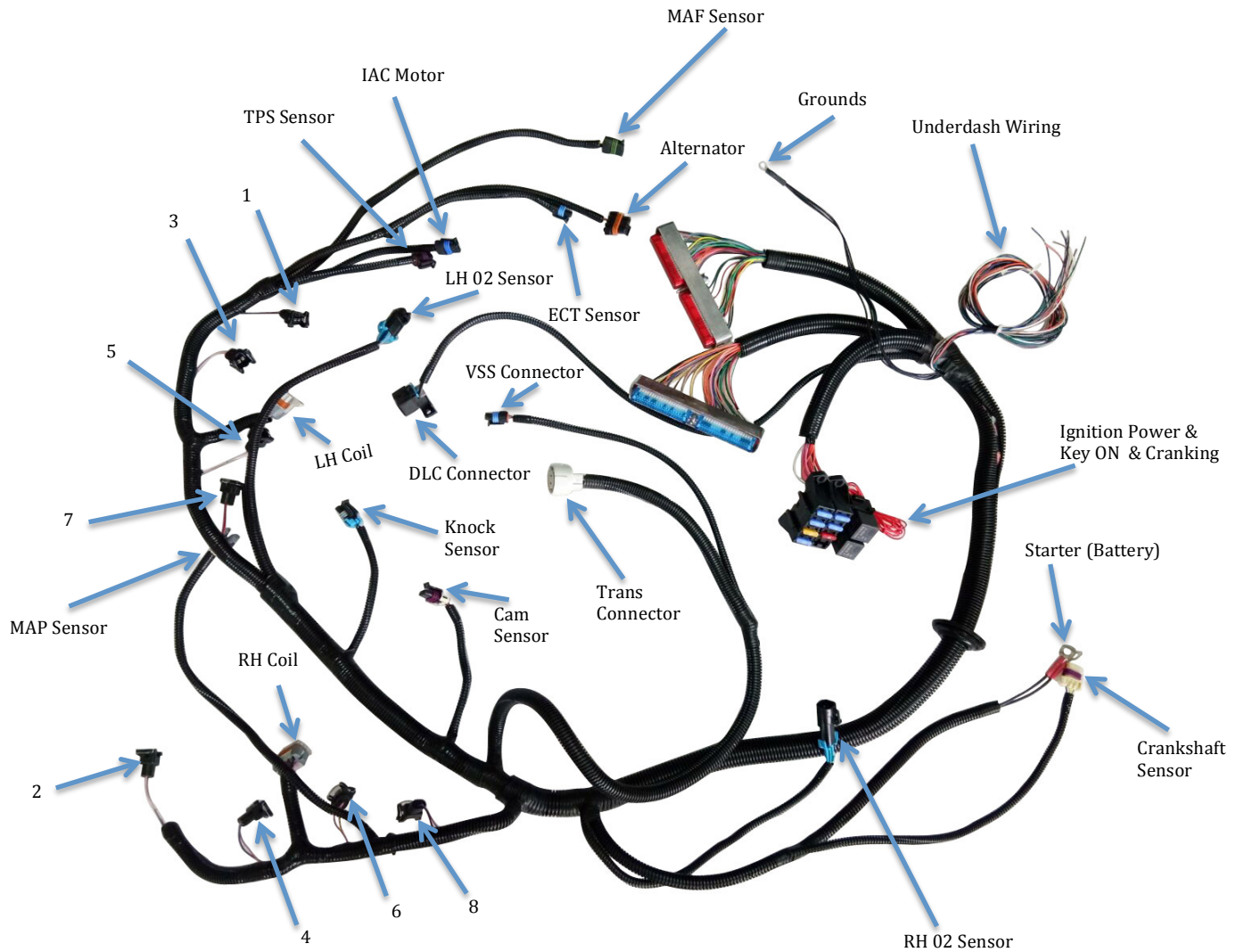

- | | |
|-----------------|-----------------|
| 1 = #1 Injector | 5 = #5 Injector |
| 2 = #2 Injector | 6 = #6 Injector |
| 3 = #3 Injector | 7 = #7 Injector |
| 4 = #4 Injector | 8 = #8 Injector |

Lab Rats Performance

Connector	Connected To	Wire Colors	Check Completed
1	#1 Fuel Injector	Pink, Black	
2	#2 Fuel Injector	Pink, Dk Green	
3	#3 Fuel Injector	Pink, Tan	
4	#4 Fuel Injector	Pink, Lt Blue	
5	#5 Fuel Injector	Pink, White	
6	#6 Fuel Injector	Pink, Yellow	
7	#7 Fuel Injector	Pink, Red	
8	#8 Fuel Injector	Pink, Dk Blue	
9	Alternator	Red	
10	ECT Sensor	Black, Yellow	
11	Cam Sensor	Brown, Pink, Red	
12	LH Coil	Black, Red, Dk Green, Brown, Lt Blue, Purple, Pink	
13	LH O2 Sensor	Tan, Purple, Black, Pink	
14	Crank Sensor	Dk Blue, Yellow, Lt Green	
15	Knock Sensor	Dk Blue, Lt Blue	
16	MAF Sensor	Yellow, Black, Pink	
17	IAT Sensor	Purple, Tan	
18	IAC Motor	Lt Green, Dk Green, Lt Blue, Red	
19	TPS Sensor	Gray, Black, Yellow	
20	MAP Sensor	Orange, Lt Green, Gray	
21	RH Coil	Black, Red, Dk Green, Brown, Lt Blue, Purple, Pink	
22	RH O2 Sensor	Tan, Purple, Green, Pink	
23	VSS Sensor	Green, Purple	
24	Transmission Connector	Lt Green, Yellow, Red, Lt Blue, Pink, Yellow, Black, Pink, Red, Dk Blue, White, Tan, Brown	
25	Starter (Battery) (2X)	Large Ring Terminals (Black)	
26	Ground	Small Ring Terminal (Black)	
27	ISS Sensor (4L80E Only)	Tan, Orange	

Table 3 – Engine Compartment Connection Checklist (Reference Figure 1)

8.0 DASH SECTION CONNECTIONS

The wires in this section consist of the DLC, Ignition Feed, MIL indicator, Speedometer/Cruise Control Signal, Tachometer, Primary Cooling Fan, Secondary Cooling Fan, Park/Neutral Signal, and Brake Signal wires.

CAUTION: DO NOT MAKE ANY CONNECTIONS WHILE THE PCM IS PLUGGED INTO THE HARNESS.

8.1 Using the specific connections indicated in Table 4, connect the wiring as directed. All connections are required unless otherwise noted.

Lab Rats Performance

NOTE: A fuel pump relay is provided with the signal side of the relay being pre-wired from Lab Rats Performance. However, in order to provide a clean installation, the feed and output sides of the relay are not wired. Lab Rats Performance has provided you with two blade terminals to complete this circuit. Ensure that properly sized and fused wiring is used, depending on the capacity of your fuel pump. Measure the length of wire needed to reach the fuel pump, strip the wire and crimp the supplied blade terminal onto the wire. Insert the terminal into the relay holder per Figure 2. Perform the same operation for wiring the power supply side of the relay ensuring that the wire is run from an appropriate fused power source.

CAUTION: BE SURE TO PROPERLY GROUND AND FUSE YOUR FUEL PUMP OR ENGINE DAMAGE MAY OCCUR.

8.2 Connect the 2 PCM connectors to the PCM, **BEING CAREFUL NOT TO BEND ANY PINS.** Connectors are color coded to prevent incorrect installation.

8.3 All wires not being used should be individually taped and secured to prevent electrical shorting.

8.4 Permanently mount your PCM and Fuse/Relay Center.

8.5 After all connections have been made throughout the harness, reconnect the battery.

CAUTION: BE SURE THE IGNITION IS OFF WHEN YOU RECONNECT THE BATTERY OR DAMAGE TO THE PCM WILL OCCUR.

NOTE: In **STOCK CONFIGURATION** Fan #1 will come ON at 226F and go OFF at 221F
Fan #2 will come ON at 235F and go OFF at 230F.

Table 4 – Underdash Wiring Checklist

UNDERDASH WIRES (BUNDLED TOGETHER)			
WIRE COLOR	CONNECTED FROM	CONNECTED TO	CHECK IF COMPLETE
Brown	MIL Lamp Ground	Through Automotive Light to 12V	
Black	Speedometer (Optional)	Speedometer Module	
White	Tachometer (Optional)	Electronic Tachometer	
Dk Green	Fan 1 Ground (Optional)	Ground Side of Customer Supplied Fan 1 Relay	
Dk Blue	Fan 2 Ground (Optional)	Ground Side of Customer Supplied Fan 2 Relay	
Orange	Park Neutral Signal (Optional) *NOT NEUTRAL SAFETY*	To Ground (In Park and Neutral)	
Purple	Brake Signal / TCC Ground	To 12V (Brakes Not Applied)	
Grey	ECT Lead (Optional)	Water Temp (98-02 F-Body Gage Cluster Only)	
Tan	Oil Pressure Lead (Optional)	Oil Pressure (98-02 F-Body Gage Cluster Only)	
UNDERDASH WIRES			
Black Multiple Wires	Chassis Ground Ring Terminal	Chassis Ground	
N/A	Fuel Pump (Line)	To 12V Battery Power	
N/A	Fuel Pump (Load)	To Fuel Pump	

Lab Rats Performance

Red	Ignition Feed (Relay Center)	12V Fused Switched Power (KEY ON and CRANKING)	
Multiple	PCM Connectors	PCM	
White	A/C Request (Optional) (at PCM Connector)	12-Volts when A/C turned ON	

CRUISE CONTROL WIRES (COMING FROM PCM CONNECTOR)			
WIRE COLOR	CONNECTED FROM	CONNECTED TO	CHECK IF COMPLETE
Green	Cruise Control (Optional)	Cruise Engaged (Cruise Control Module)	
White	Cruise Control (Optional)	Cruise Inhibit (Cruiser Control Module)	

Table 4 – Underdash Wiring Checklist

9.0 TROUBLE SHOOTING INSTRUCTIONS

If you are having trouble with your engine running poorly or not running at all, first perform basic trouble shooting (ensure that you are using the correct parts, see Table 2), check for faulty connections, blown fuses, disabling of VATS in PCM, spark, timing, fuel pressure, etc., then see if the PCM has stored a trouble code in its memory.

CHECK THE FOLLOWING ITEMS PRIOR TO CONTACTING Technical Support.

NO-START

1. Red Ignition Wire (From back of Fuse/Relay Center) has 12-volts with the Key in the **ON** position and **CRANKING** positions. This cannot be stressed enough, most NO-START conditions can be traced to this wiring issue.
2. Check Fuel Pressure for correct value (Approximately 58-psi).
3. Check that Fuel Injectors are firing. In many cases, engines which have been sitting for a few months have old fuel which has turned to varnish and clogged the injectors. A simple way to check if the injectors are clogged is to place a NOID LIGHT (Available at most autoparts stores) in the injector plug while cranking the engine. If the plug lights up, then the injectors are being commanded to fire. If the spark plugs are firing, the fuel pressure is correct, then the injectors are clogged and must be cleaned.

COOLING FANS STAY RUNNING

1. Check Engine Light is connected properly.
2. Trouble Codes exist.

Lab Rats Performance

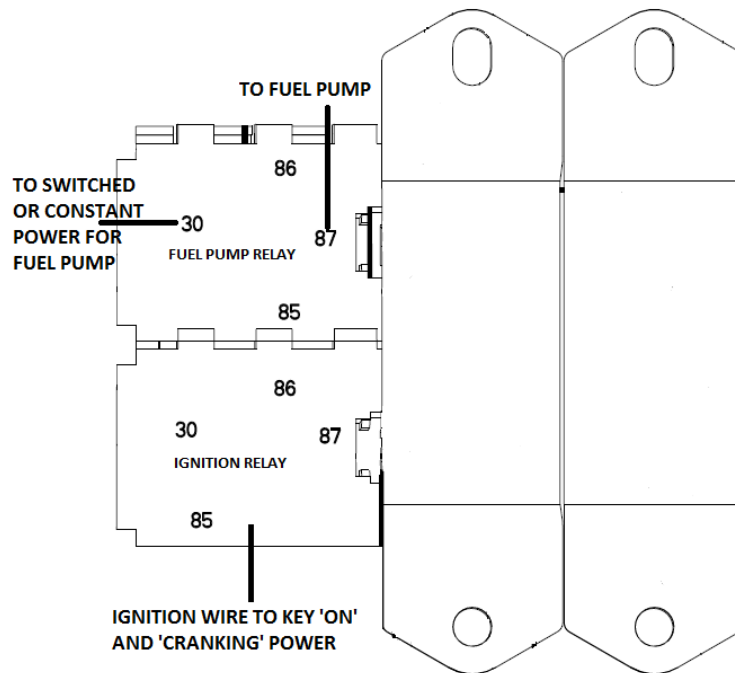
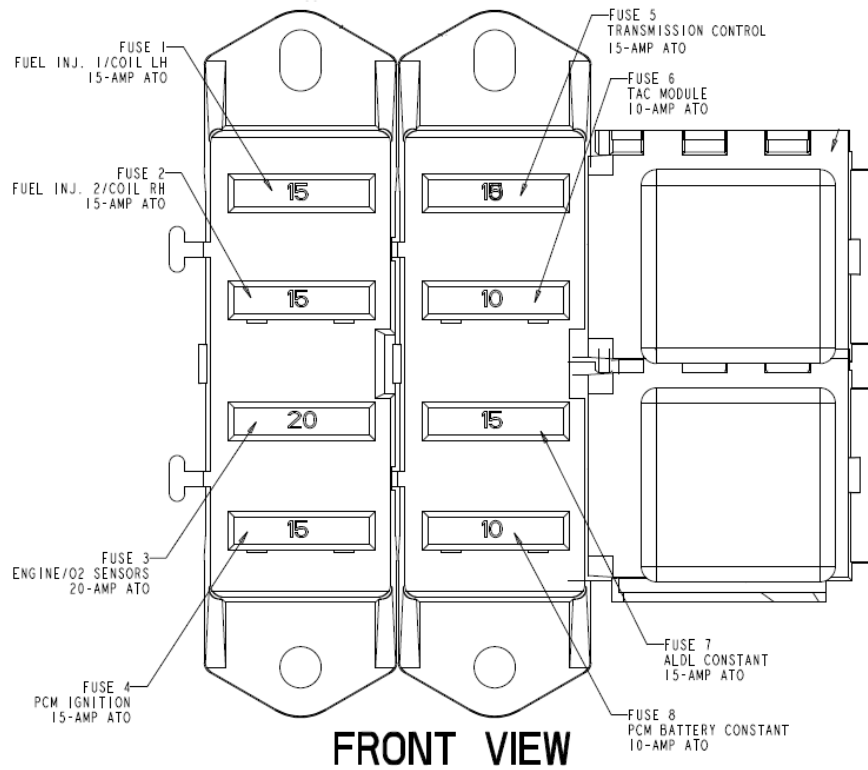

Lab Rats Performance

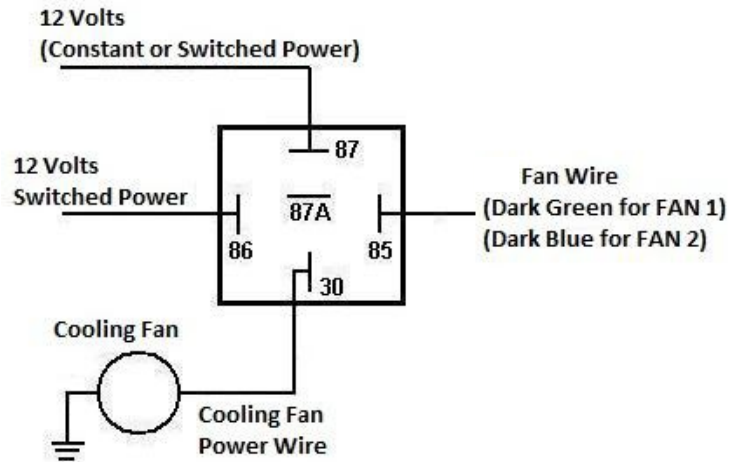

Cooling Fan Relay Diagram

(PURPLE WIRE
TO THIS
TERMINAL)

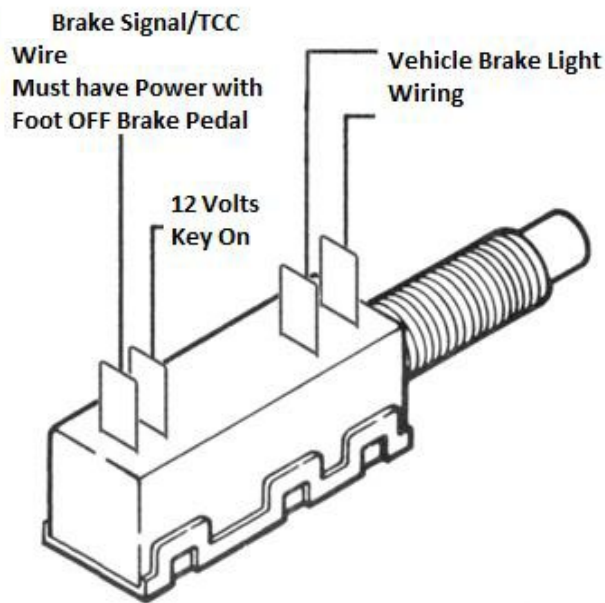

TCC Brake Switch Diagram

Lab Rats Performance

TACHOMETER READING INCORRECT

1. Make sure TACH is set for 4 CYLINDER Mode.
2. Most AUTOMETER brand Tach gauges require a resistor to be added to the tach circuit. Follow the diagram below to add the resistor.

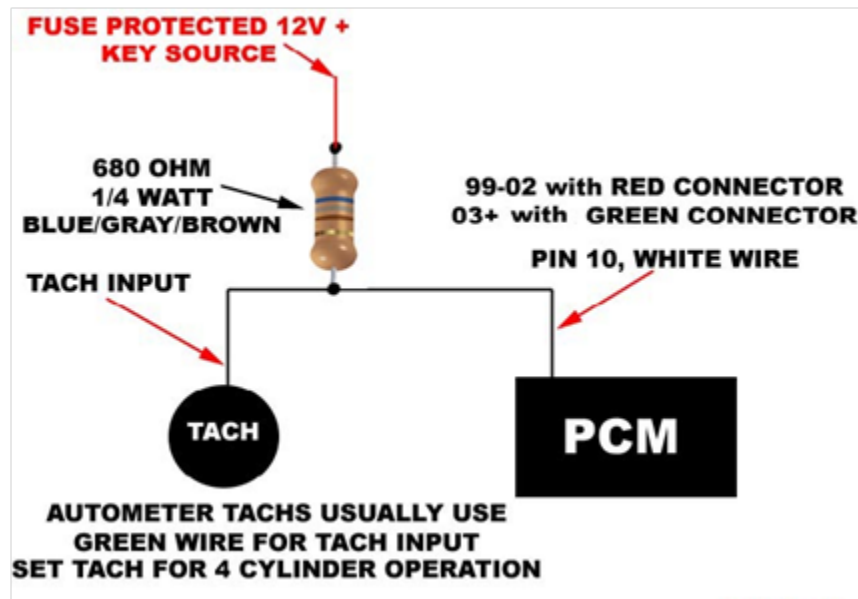

9.1 "CHECK ENGINE" LIGHT

Normally, the "Check Engine" or "MIL" indicator light should come on when the ignition is turned on, then go out a few moments after the engine starts running. If it reappears, or stays on while the engine is running, the PCM has detected a problem and a trouble code has been set.

9.2 RETRIEVING TROUBLE CODES FROM THE PCM

9.2.1 In order to retrieve the trouble codes stored in the PCM, a scanner must be connected to the DLC connector. Follow the instructions provided with the scanner to read the codes set in the PCM. (Normally with the ignition in the "ON" position, but with the engine NOT running).

9.2.2 After you have read any codes, document them for reference. Remove the connector from the DLC connector.

NOTE: A code indicates a problem in a specific circuit, **NOT THAT A PARTICULAR PART IS DEFECTIVE.**

9.2.4 Before taking more extensive correction actions for any trouble codes, make sure that all connections on the indicated circuit, **INCLUDING THE PCM**, are clean and tight. Inspect the wiring in the circuit for any broken, shorted, or exposed wires. Finally, insure all ground wires are clean and secure.

9.2.5 If a trouble code is detected and the problem has been fixed, clear the codes by first making sure the ignition is off, then disconnecting the **NEGATIVE** battery cable for at least 3 minutes.

10.0 TECHNICAL SUPPORT

Lab Rats Performance

Before contacting us, please double check all connections and perform normal basic trouble shooting (fuel pressure, timing, ignition system, etc.).

(SEE TABLE 2 FOR COMPATIBLE REPLACEMENT SENSOR PART NUMBERS)

TABLE 2. COMPATIBLE PARTS

Item Description	Part Number
Main Computer (PCM)	GM Service# 9354896 or 12200411
Intake Air Temperature (IAT) Sensor	GM# 12160244 / Delco# 213-243
Manifold Absolute Sensor (MAP) Sensor	GM# 16212460 / Delco# 12614970
Idle Air Control (IAC) Sensor	GM# 17113391
Engine Coolant Temperature (ECT) Sensor	GM# 15326388 / Delco# 213-953
Engine Coolant Temp Sensor (3 wire for F-Body gauge cluster ONLY)	Delco# 12551708 (3 wire sensor used with F-Body Gauge cluster ONLY)
Oil Pressure Sensor	GM# 12562267 (For use with F-Body Gauge cluster ONLY)
Knock Sensor	GM# 10456603 / Delco# 213-3521
Ignition Coil	GM# 12558948 / Delco# D-580
Oxygen (O2) Sensor	GM# 25161131 / Delco# AFS123
Throttle Position Sensor (TPS)	GM# 17123852 / Delco# 213-912
Mass Air Flow (MAF) Sensor (3 PIN)	GM# 25179711 / Delco#2134657
Mass Air Flow (MAF) Sensor (5 PIN)	GM# 25168491 / Delco# 213-364
Cam Position Sensor	GM# 12561211 / Delco# 213-363
Crankshaft Position Sensor	GM# 12560228 / Delco# 213-354